

E Style MicroPak™ Enclosures

Technical Data



Extruded base with slide-in flat panel

WEB/FAX DOCUMENT

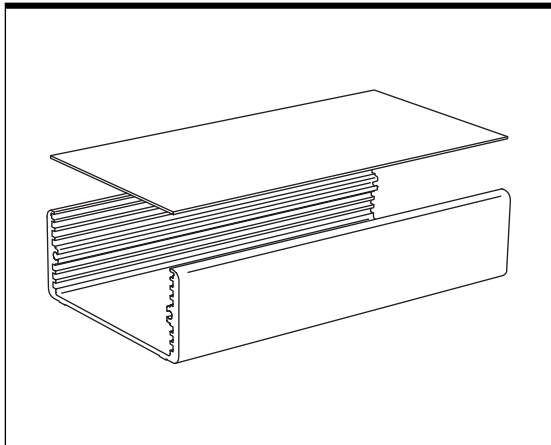

E Style Extruded Base/Panel

Sizes (widths/heights): Below
Enclosure cross sections: Page 2
Drawings/dimensions: Pages 3-7
Materials/finishes: Pages 3-6

Widths and heights:

E Style is available in six standard sizes as defined by height and width combinations tabulated below. Standard depths for each size are shown on pages 7 and 8. Other depths are made to order.

Inch Dimensions (in)

HEIGHT	WIDTH	N	Q	T	W
.75	▪				
1.12	▪	▪		▪	
1.52			▪	▪	
2.52					
PCB Width		2.51	3.94 Euro card	5.28	7.00

Metric Dimensions (mm)

HEIGHT	WIDTH	N	Q	T	W
19.1	▪				
28.5	▪	▪		▪	
38.6			▪	▪	
64.0					
PCB Width		63.7	100 Euro card	134.1	177.8

End Configuration Options

End Panel / Thinline Bezel:

Two piece. Aluminum panel recessed into molded bezel.

Page 4 – N Width
 Page 6 – Q and T Width

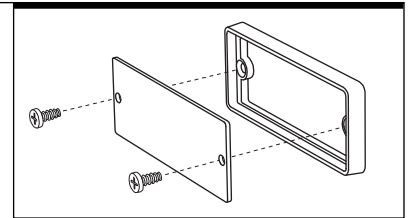

Solid End Cap:

One piece. Molded polycarbonate end.

Page 4 – N Width
 Page 6 – Q and T Width

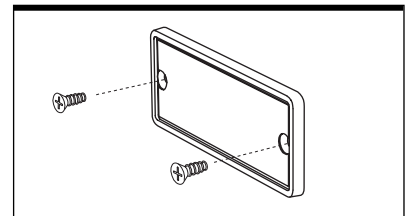

Battery Compartment:

Houses 9-volt battery. Molded polycarbonate. (Fits N2. Can be used with other sizes.)

Page 4 – N Width

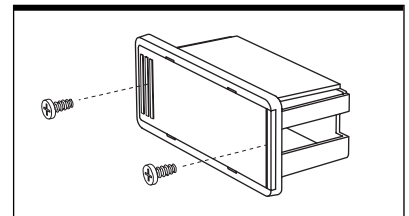

Model Number Designation:



Model numbers for standard enclosures.

Model and part numbers for customized enclosures and parts.

Page 8

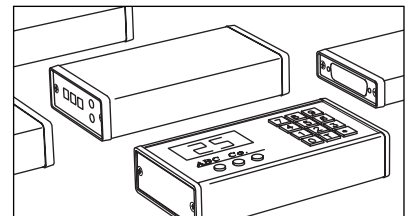

Accessories:

Rack Mount Panels.

Non-Skid Feet.

Page 9

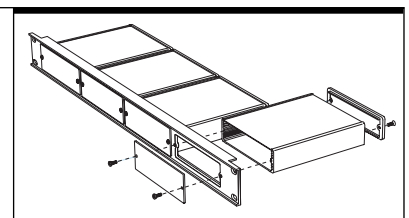



N Width

PCB width = 2.51 (63.7)

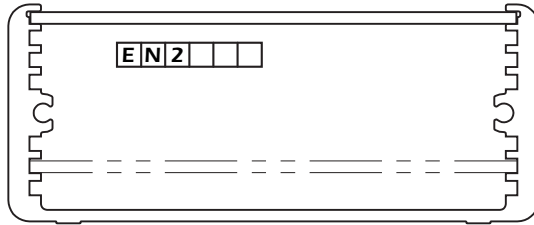
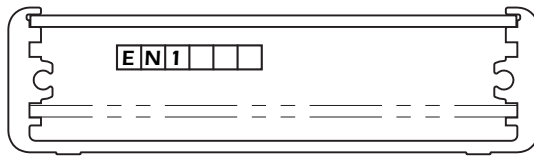

Enclosure Cross Sections:

The cross section of each size of enclosure is shown. The recommended printed circuit board widths are referenced.

Q Width

PCB width = 3.94 (100.0)

Accepts 100 mm Eurocards.

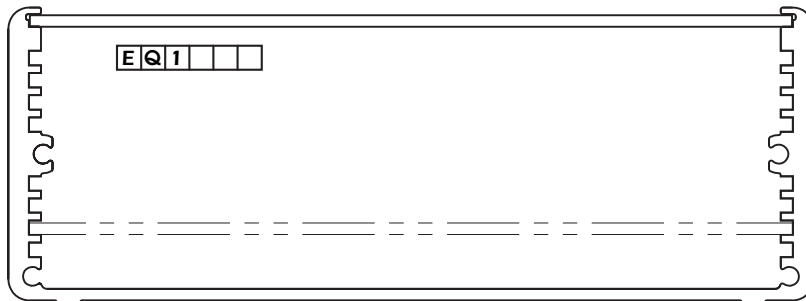
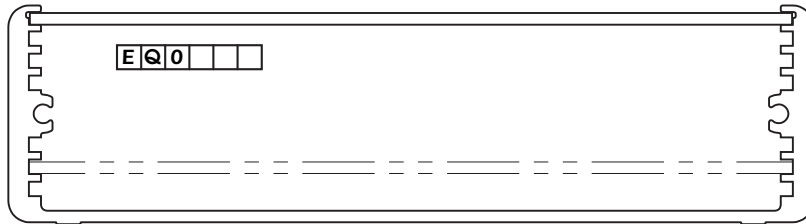

T Width

PCB width = 5.28 (134.1)

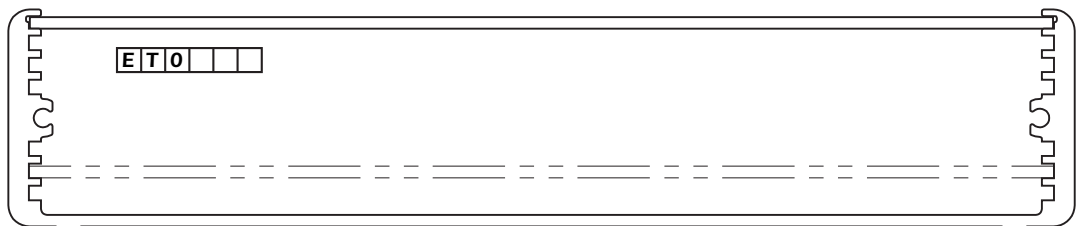

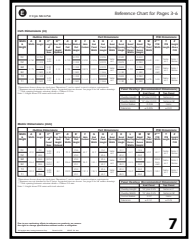
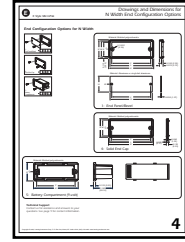
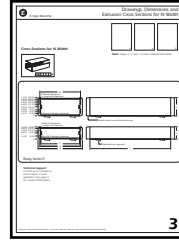

Cross Sections for N Width

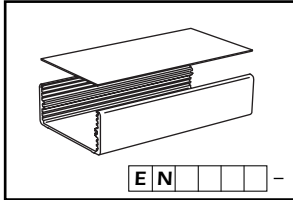

Note: Pages 3, 4 and 7 contain related information.

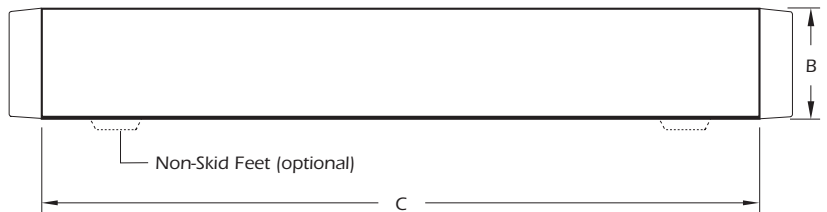
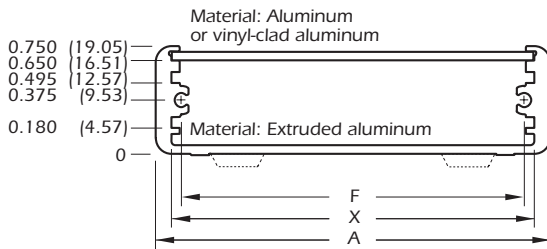
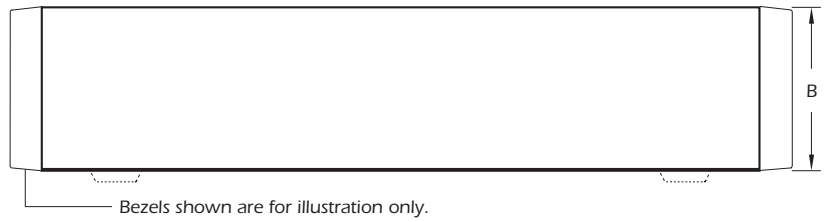
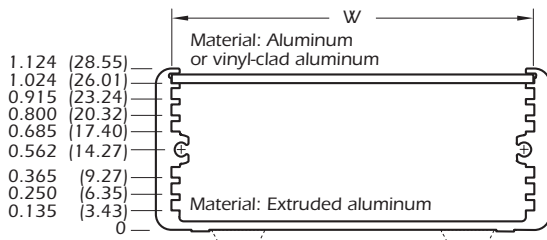

Body Series E

Technical Support

Contact us for assistance and answers to your questions. See page 9 for contact information.



End Configuration Options for N Width

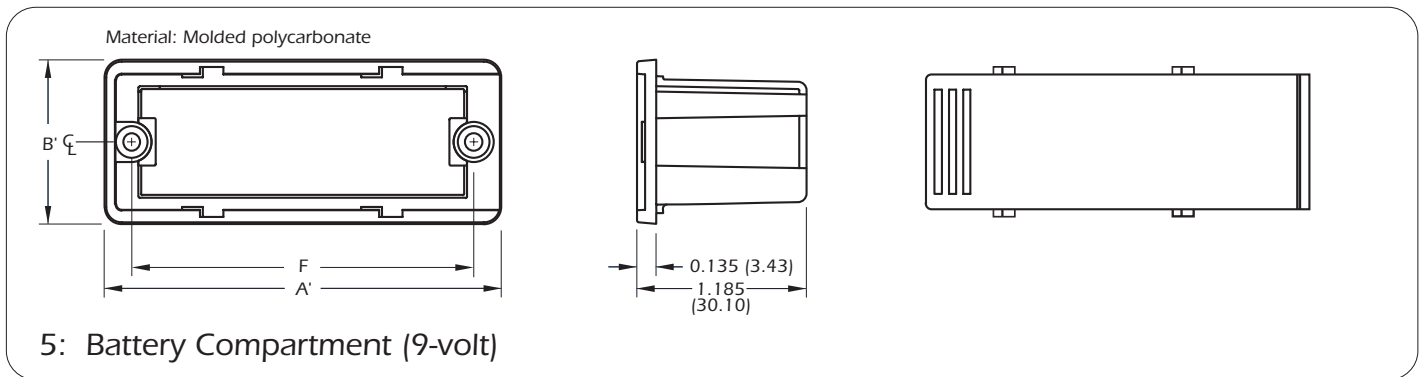
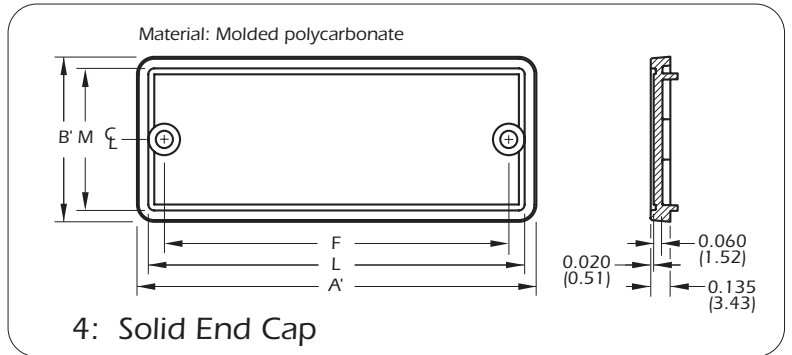
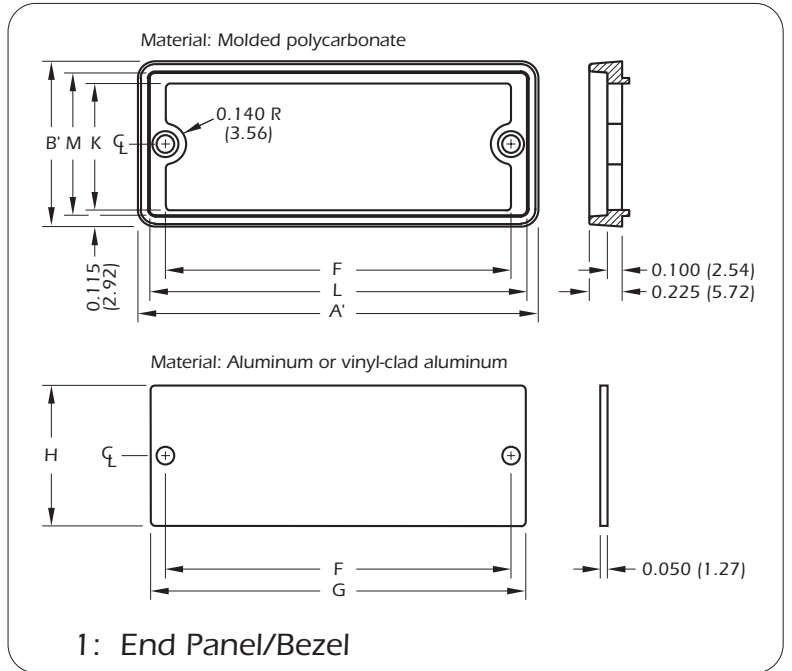
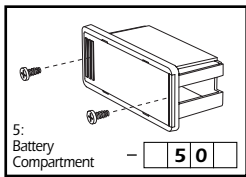
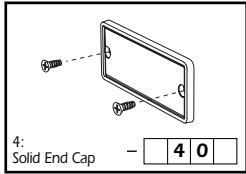
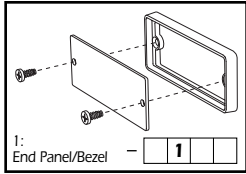

Technical Support

Contact us for assistance and answers to your questions. See page 9 for contact information.

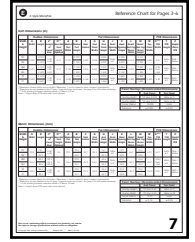
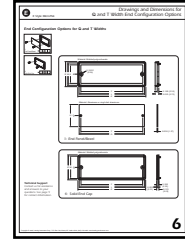
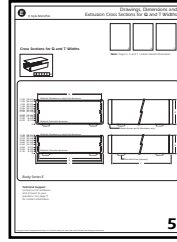

Cross Sections for Q and T Widths

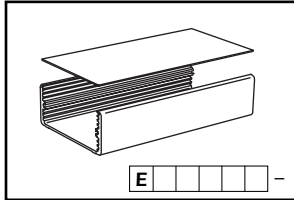

Note: Pages 5, 6 and 7 contain related information.

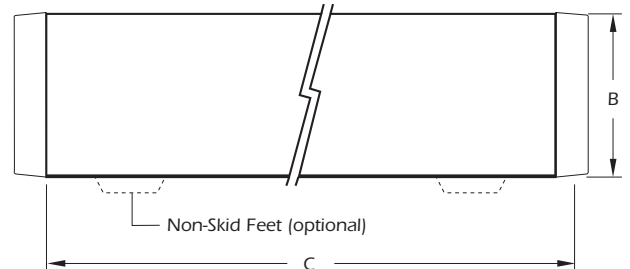
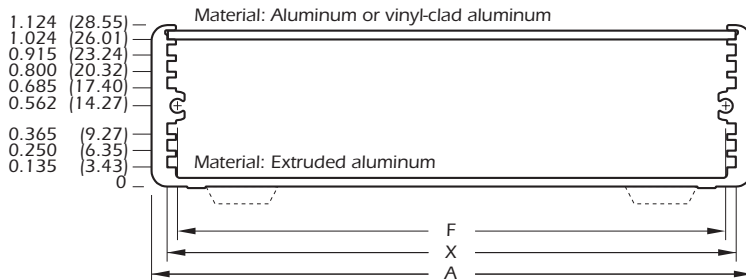
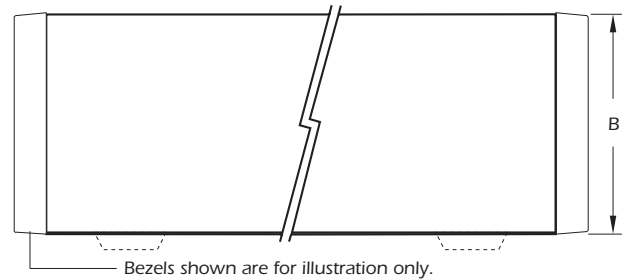
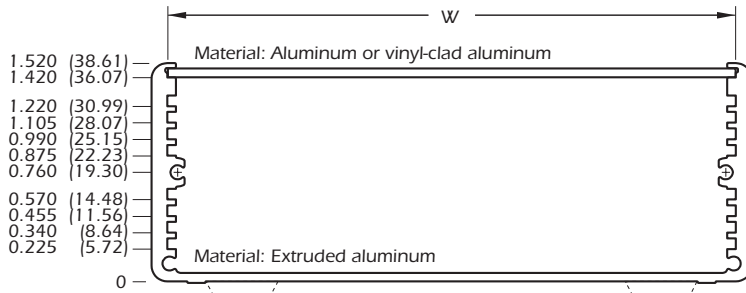

Body Series E

Technical Support
Contact us for assistance and answers to your questions. See page 9 for contact information.



End Configuration Options for Q and T Widths

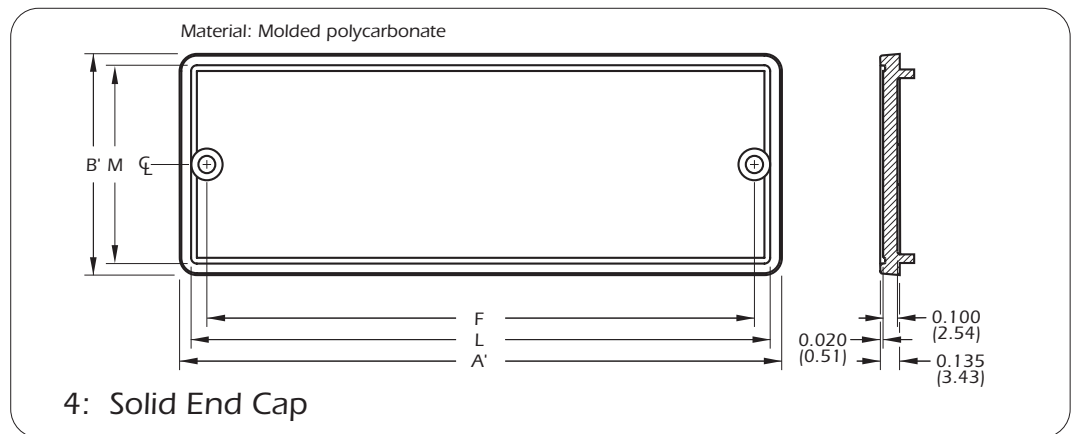
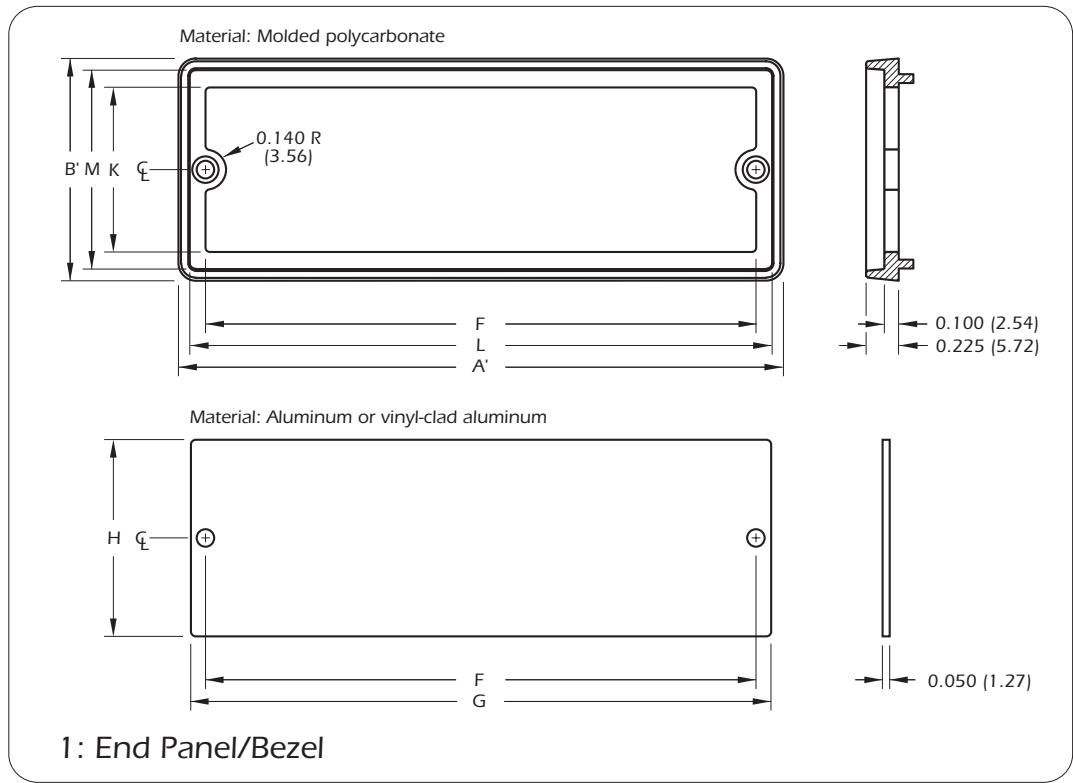
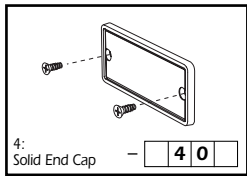
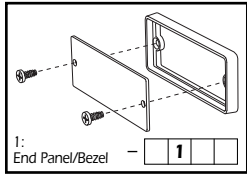

Technical Support
 Contact us for assistance and answers to your questions. See page 9 for contact information.



Inch Dimensions (in)

Width & Height	Outline Dimensions				Part Dimensions									PCB Dimensions			
	A Width	B Height	C* Length of Cover/Base	D** Non-Skid Foot Height Optional	A' Molded Part Width	B' Molded Part Height	F Hole Centers	G End Panel Width	H End Panel Height	J Bezel Opening Width	K Bezel Opening Height	L Bezel/ End Cap Recess Width	M Bezel/ End Cap Recess Height	W Top Panel Width	X*** PCB Width	Y PCB Length	Z Height Above PCB
N1	2.750	0.750	5.00 6.00	0.10	2.770	0.770	2.390	2.596	0.596	Same as F	0.500	2.610	0.610	2.520	2.51	Same as C	Note 1 Below
N2		1.124				1.144			0.970				0.984				
Q0	4.175	1.124	5.00 6.00 6.30	0.12	4.195	1.144	3.815	4.021	0.970	Same as F	0.804	4.035	0.984	3.940	3.94 Euro card	Same as C	Note 1 Below
Q1		1.520				1.540			1.366				1.380				
T0	5.528	1.124	6.00 7.00	0.12	5.548	1.144	5.168	5.374	0.970	Same as F	0.804	5.388	0.984	5.295	5.28	Same as C	Note 1 Below
T1		1.520				1.540			1.366				1.380				

*Dimensions shown above are stock sizes. Dimension C can be varied to meet customer requirements.

**Bump-ons are not standard in the E Series. Suggested sizes are shown. See page 8 for full outline drawings.

***Clear opening between extrusion details = X minus 0.23 in.

Note 1: Height above PCB varies with track selected.

Panel Overlays (Recommended Dimensions)		
	End Panel	Top Panel
Overlay Height	"H" plus 0.010	Same as C
Overlay Width	"G" plus 0.010	Same as W
Corner Radius	0.038	none
Tolerance	± 0.005	± 0.01

Metric Dimensions (mm)

Width & Height	Outline Dimensions				Part Dimensions									PCB Dimensions			
	A Width	B Height	C* Length of Cover/Base	D** Non-Skid Foot Height Optional	A' Molded Part Width	B' Molded Part Height	F Hole Centers	G End Panel Width	H End Panel Height	J Bezel Opening Width	K Bezel Opening Height	L Bezel/ End Cap Recess Width	M Bezel/ End Cap Recess Height	W Top Panel Width	X*** PCB Width	Y PCB Length	Z Height Above PCB
N1	69.8	19.1	5.00 6.00	2.5	70.4	19.6	60.7	65.9	15.1	Same as F	12.7	66.3	15.5	64.0	63.7	Same as C	Note 1 Below
N2		28.5				29.0			24.6				22.2				
Q0	106.0	28.5	127.0 152.4 160.0	3.1	106.6	29.0	96.9	102.1	24.6	Same as F	20.4	102.5	25.0	100.1	100.0 Euro card	Same as C	Note 1 Below
Q1		38.6				39.1			34.7				28.9				
T0	140.4	28.5	6.00 7.00	3.1	140.9	29.0	131.3	136.5	24.6	Same as F	20.4	136.9	25.0	136.9	134.1	Same as C	Note 1 Below
T1		38.6				39.1			34.7				28.9				

*Dimensions shown above are stock sizes. Dimension C can be varied to meet customer requirements.

**Bump-ons are not standard in the E Series. Suggested sizes are shown. See page 8 for full outline drawings.

***Clear opening between extrusion details = X minus 5.8 mm.

Note 1: Height above PCB varies with track selected.

Panel Overlays (Recommended Dimensions)		
	End Panel	Top Panel
Overlay Height	"H" plus 0.25	Same as C
Overlay Width	"G" plus 0.25	Same as W
Corner Radius	0.97	none
Tolerance	± 0.12	± 0.25

Due to our continuing efforts to enhance our products, we reserve the right to change specifications without notice or obligation.



Model Numbers for Standard Enclosures:

Make your configuration selections and transfer the alpha-numeric codes to the appropriate boxes in the model number below. Fill in any empty boxes with choices from the tables. The resulting model number completely specifies the E Style MicroPak of your choice. The price of this model number can be found on page 3 of our separate MicroPak Price List. Ordering information can be found on page 5 of that same document.

Product Dimensions and Color of Extruded Base → **Front End Configuration Choices** → **Rear End Configuration Choices** → **Optional Non-Skid Feet**

Base Configuration
The concept of the base configuration has been created to simplify pricing. If the enclosure consists only of choices from these interconnected boxes, then the price is simply the price shown in the base configuration column of the price list. If the enclosure consists of choices from outside the base configuration boxes, then the price is that of the base configuration plus the marginal cost of the options chosen.

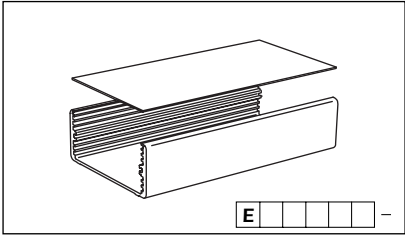

E -

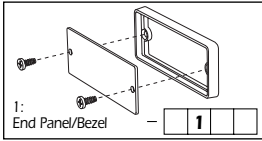

1: End Panel/Bezel -

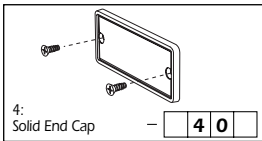

4: Solid End Cap -

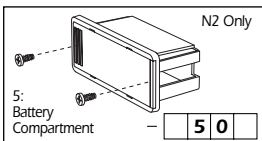

5: Battery Compartment -

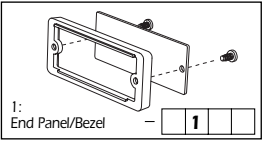

1: End Panel/Bezel -

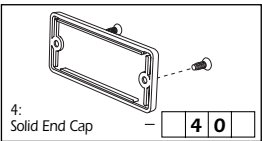

4: Solid End Cap -

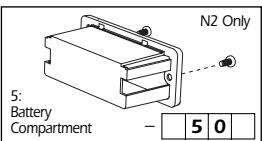

5: Battery Compartment -

Non-skid feet are optional on E-Style Enclosures. If required place the letter **F** in the box below.
- **F**

Otherwise leave the box blank.
-

Model Number: E - - -

(Use only if different from front)

Dimensions - inch (metric)

Width	Height	Length
N = 2.75 (69.8)	1 = 0.75 (19.1)	5 = 5.00 (127.0)
	2 = 1.12 (28.4)	6 = 6.00 (152.4)
Q = 4.17 (106.0)	0 = 1.12 (28.4)	5 = 5.00 (127.0)
	1 = 1.52 (38.6)	6 = 6.00 (152.4)
		E = 63.0 (160.0)
T = 5.53 (140.4)	0 = 0.52 (28.4)	6 = 6.00 (152.4)
	1 = 1.52 (38.6)	7 = 7.00 (177.8)

Color Choices

Extruded Base	Bezel, End Cap, Battery Comp.
P = Pearl White	P = Pearl White
E = Pebble Gray	E = Pebble Gray
* = Shale Gray	S = Shale Gray
T = Platinum	T = Platinum
G = Medium Gray	G = Medium Gray
B = Black	B = Black

* Not available

Top Panel Choices

Aluminum (.060 thick)

A = Clear Anodize

B = Black Anodize

Powdercoated Aluminum

H = Pearl White

J = Pebble Gray

L = Platinum

M = Medium Gray

N = Black

Vinyl-clad Aluminum

P = Pearl White

E = Pebble Gray

T = Platinum

G = Medium Gray

K = Black

Aluminum (.050 thick)*

D* = Gold Iridite

* For use with .010 overlays only

X = No top panel

End Panel Choices

Aluminum

A = Clear Anodize

B = Black Anodize

C = Clear Iridite

R = Raw Aluminum with vinyl protection

Vinyl-clad Aluminum

P = Pearl White

E = Pebble Gray

T = Platinum

G = Medium Gray

K = Black

X = No end panel

Screw Choices

Standard (3/8" long)

1* = Pan Head Silver

2* = Pan Head Black

3 = Flat Head Silver

4 = Flat Head Black

Optional (5/8" long)

6* = Pan Head Silver

7* = Pan Head Black

8 = Flat Head Silver

* Not available on end configurations "4" and "5"

Model and Part Numbers for Customized Enclosures and Parts:

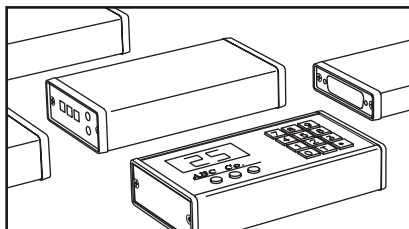

Each **customized enclosure** is assigned a model number in the following format:

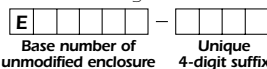

Associated with this model number is a bill of materials that identifies each individual part, standard or customized, making up the complete unit. Customized enclosures may be ordered by this model number or by individual part numbers.

Each **customized part** is assigned a part number in the following format:

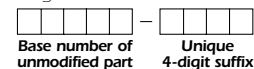

This number is assigned when an order is placed. A master drawing, used for manufacture and inspection, is then created for each part. This drawing is submitted for customer approval before the part can be manufactured.



E Style MicroPak

Accessories

Rack Mount Panels

All MicroPak Enclosures can be mounted in a standard 19-inch rack by using a Rack Mount Panel. The 14 stock varieties of Rack Mount Panels for mounting E Style plus two sizes of blank panel are shown below. Other configurations are available on special order. The model number associated with each variety is for a clear anodize finish. For black anodize, change the last "A" to a "B".

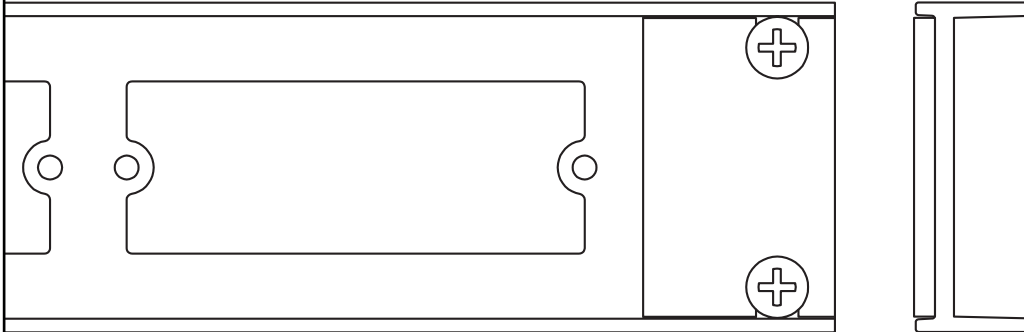

Detail from Model K1PCN2-H06A (seen below) and extrusion cross section. Also shown is one of two required spacers that are included with each Rack Mount Panel.

N Width

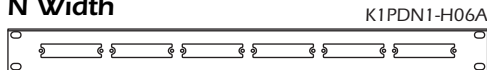

K1PDN1-H06A

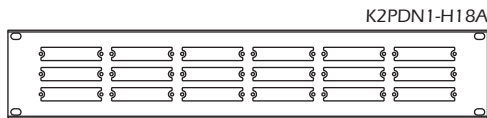

K2PDN1-H18A

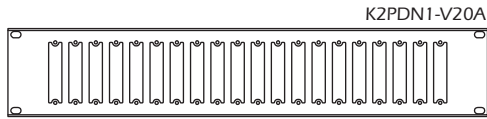

K2PDN1-V20A

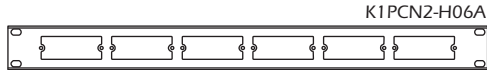

K1PCN2-H06A

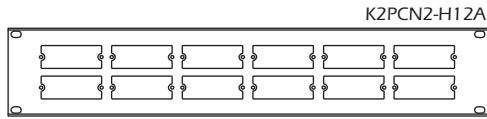

K2PCN2-H12A

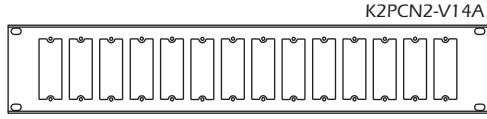

K2PCN2-V14A

Blank Panels



K1P000-001A

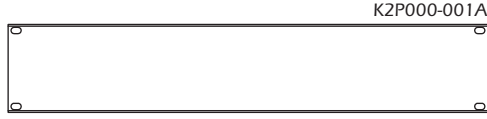

K2P000-001A

Q Width

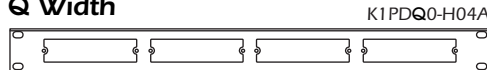

K1PDQ0-H04A

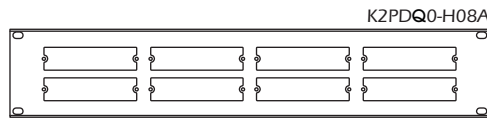

K2PDQ0-H08A

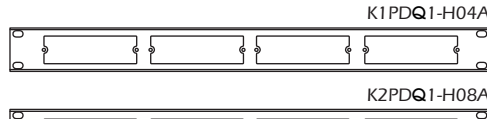

K1PDQ1-H04A

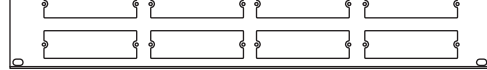

K2PDQ1-H08A

T Width

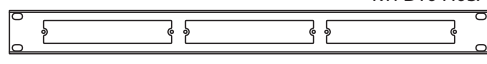

K1PDT0-H03A

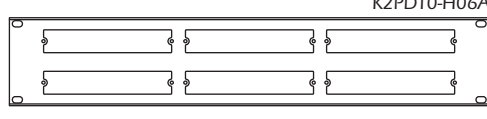

K2PDT0-H06A

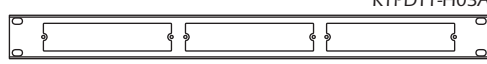

K1PDT1-H03A

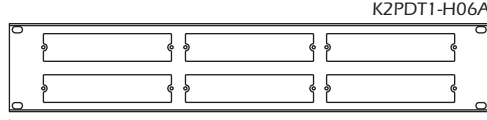

K2PDT1-H06A

18.95 (481.3)
(for standard 19-inch rack)

Note: Pricing for these Rack Mount Panels can be found on page 4 of our separate MicroPak Price List. Ordering information can be found on page 5 of that same document.

Non-Skid Feet

Self-adhesive black feet. Sold individually.

Model Numbers: KFT10-BLK 0.10 (2.5) tall
KFT12-BLK 0.12 (3.1) tall
KFT23-BLK 0.23 (5.8) tall

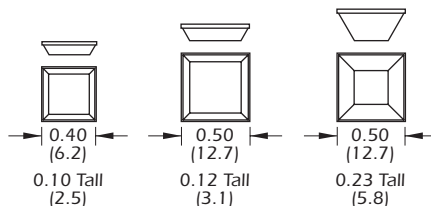

Refer to our **MicroPak Brochure** for detailed narrative and full-color photos.



Price List
Find MicroPak prices.

Order Form/Sample Offer
Place an order or purchase a sample MicroPak at a special introductory no-risk offer price.

Technical Support
Contact us for assistance and answers to your questions.

How to Contact Lansing

Phone:
800-847-3535
Anywhere in the U.S. or Canada
607-272-3265

Fax:
607-277-1953

Visit our website:
www.lansing-enclosures.com

E-mail:
info@lansing-enclosures.com

Mail:
Lansing Instrument Corp.
PO Box 730
Ithaca, NY 14851-0730

