

D Style MicroPak™ Enclosures

Technical Data



One-piece, seamless extruded tube

WEB/FAX DOCUMENT

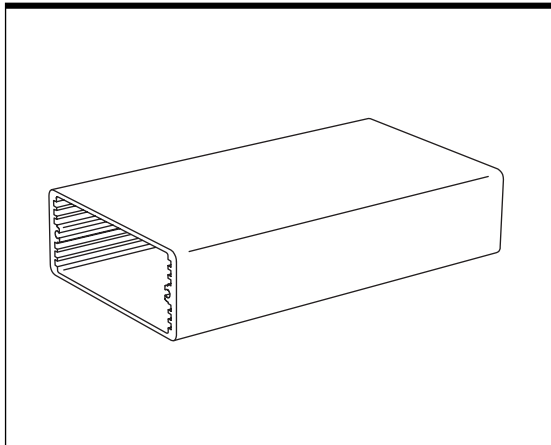

D Style Extruded Tubular Body

Sizes (widths/heights): Below
Enclosure cross sections: Page 2
Drawings/dimensions: Pages 3-7
Materials/finishes: Pages 3-6

Widths and heights:

D Style is available in six standard sizes as defined by height and width combinations tabulated below. Standard depths for each size are shown on pages 7 and 8. Other depths are made to order.

Inch Dimensions (in)

HEIGHT	WIDTH	N	Q	T	W
.75	▪				
1.12	▪	▪		▪	
1.52			▪	▪	
2.52					
PCB Width		2.51	3.94 Euro card	5.28	7.00

Metric Dimensions (mm)

HEIGHT	WIDTH	N	Q	T	W
19.1	▪				
28.5	▪	▪		▪	
38.6			▪	▪	
64.0					
PCB Width		63.7	100 Euro card	134.1	177.8

End Configuration Options

End Panel / Thinline Bezel:

Two piece. Aluminum panel recessed into molded bezel.

Page 4 – N Width
 Page 6 – Q and T Width

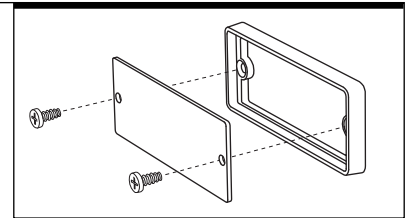

Extended Metal Panel:

One piece. Aluminum panel with choice of two mounting holes (all sizes) or four mounting holes (DQ1 and DT1 only).

Page 4 – N Width
 Page 6 – Q and T Width

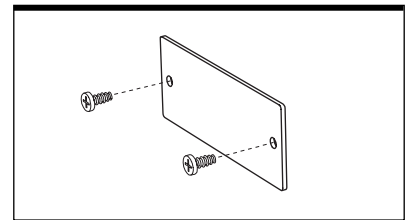

Solid End Cap:

One piece. Molded polycarbonate end.

Page 4 – N Width
 Page 6 – Q and T Width

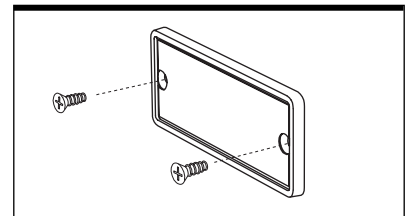

Battery Compartment:

Houses 9-volt battery. Molded polycarbonate. (Fits N2.) Can be used with other sizes.)

Page 4 – N Width

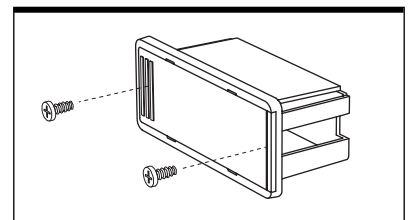

Model Number Designation:



Model numbers for standard enclosures.

Model and part numbers for customized enclosures and parts.

Page 8

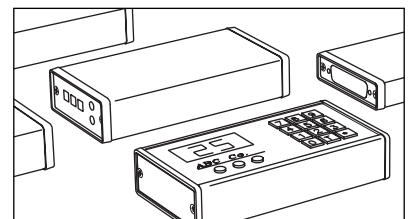

Accessories:

Rack Mount Panels.

Non-Skid Feet.

Page 9

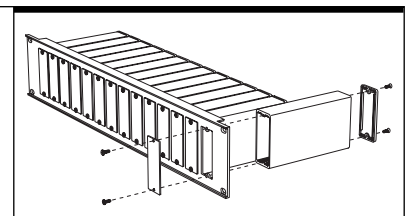



N Width

PCB width = 2.51 (63.7)

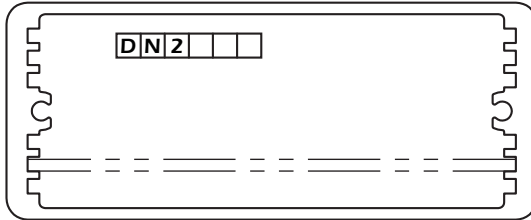
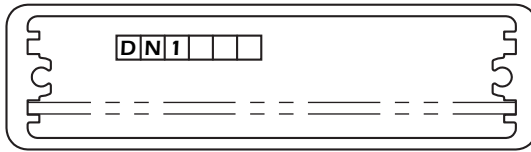

Enclosure Cross Sections:

The cross section of each size of enclosure is shown. The recommended printed circuit board widths are referenced.

Q Width

PCB width = 3.94 (100.0)

Accepts 100 mm Eurocards.

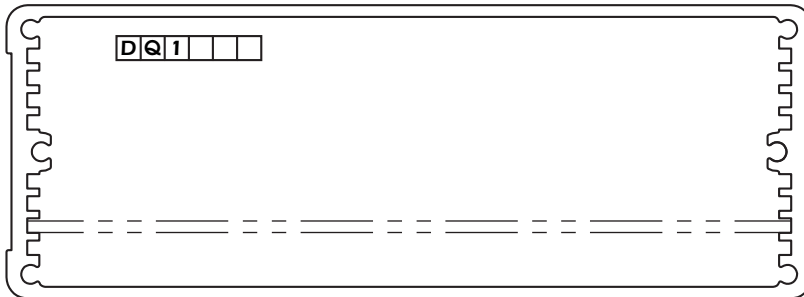
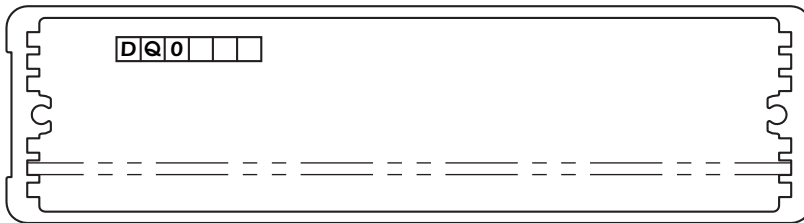

T Width

PCB width = 5.28 (134.1)

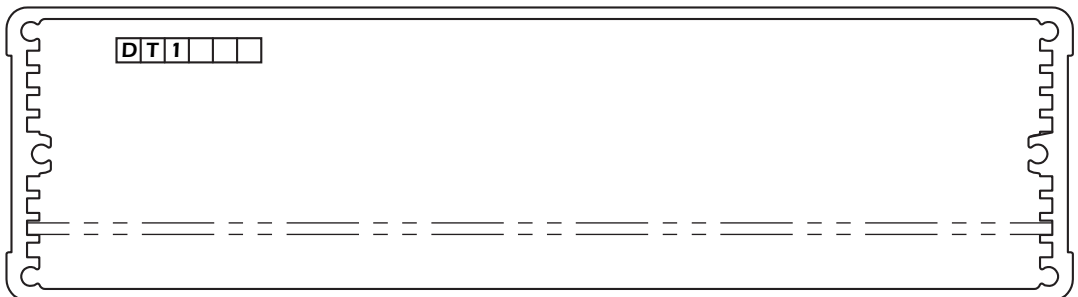
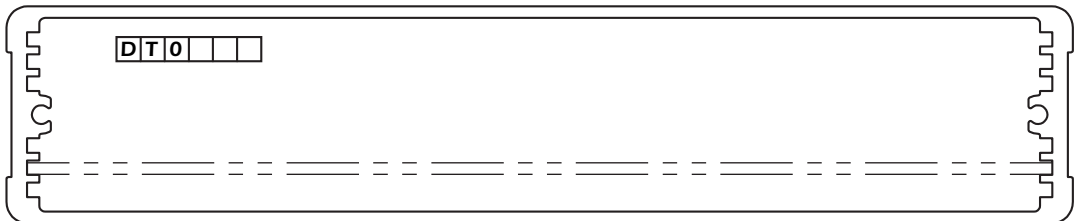

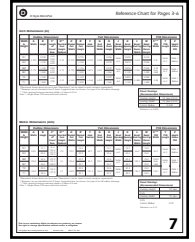
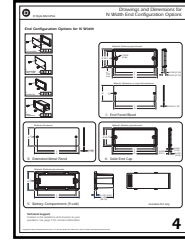
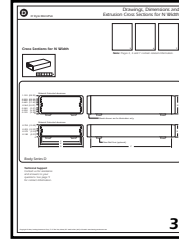

Cross Sections for N Width

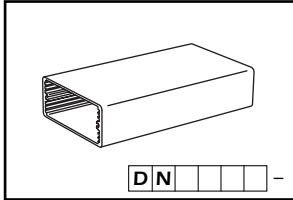

Note: Pages 3, 4 and 7 contain related information.

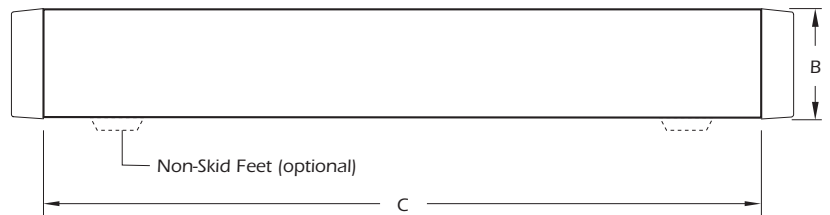
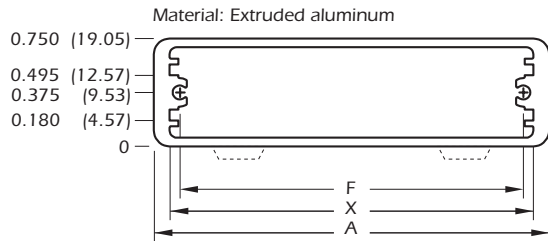
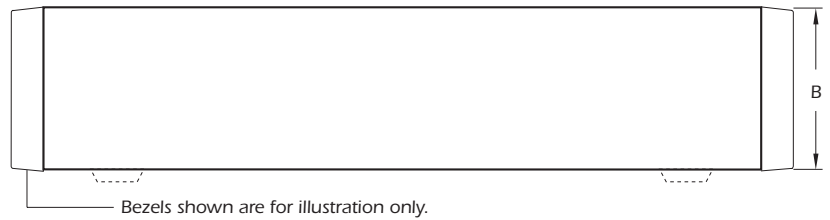
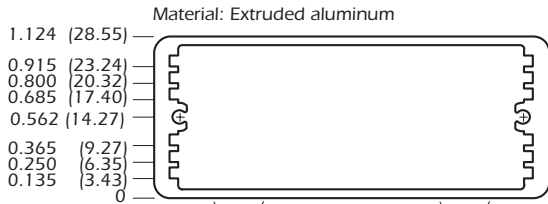

Body Series D

Technical Support

Contact us for assistance and answers to your questions. See page 9 for contact information.



End Configuration Options for N Width

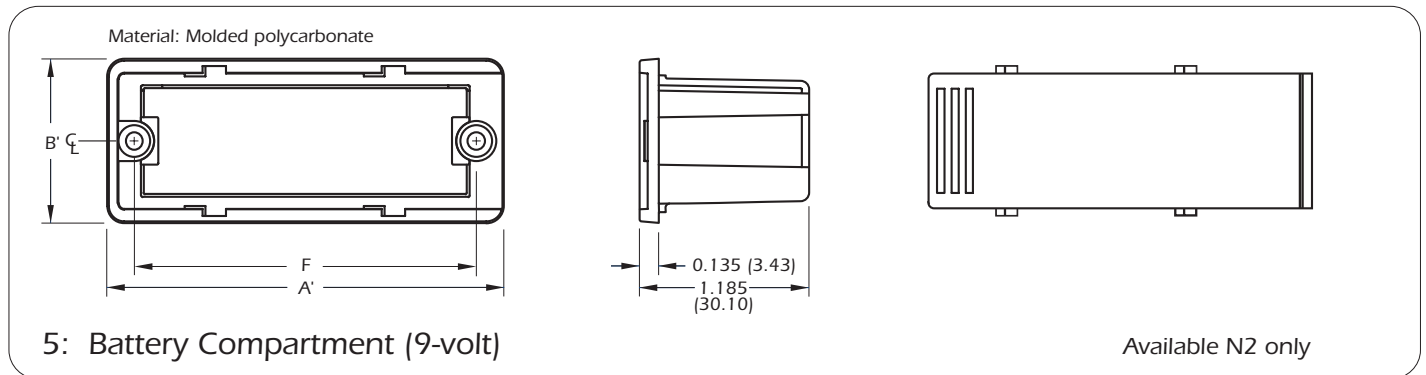
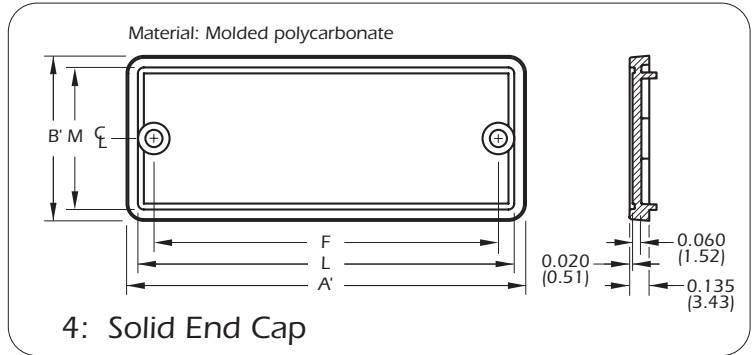
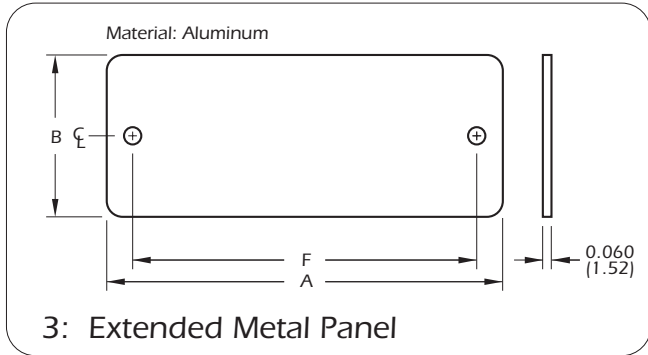
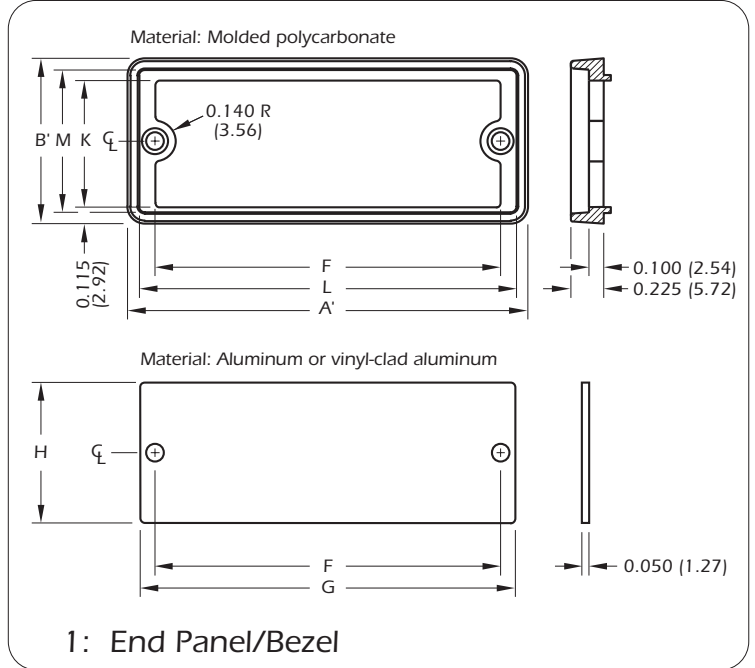
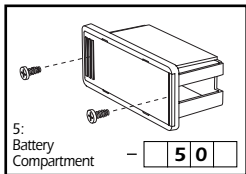
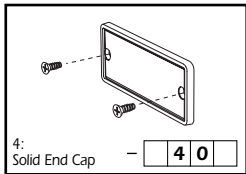
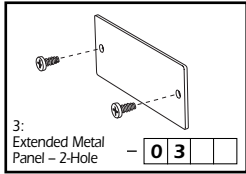
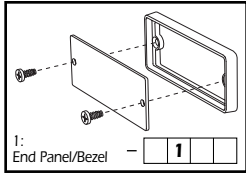

Technical Support

Contact us for assistance and answers to your questions. See page 9 for contact information.

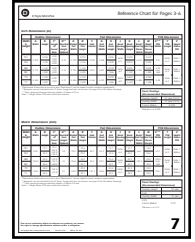
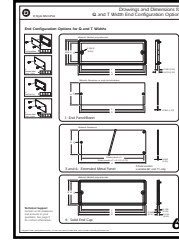
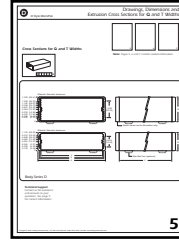

Cross Sections for Q and T Widths

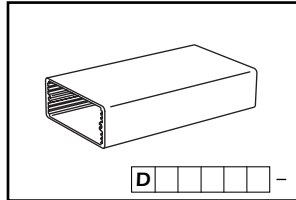

Note: Pages 5, 6 and 7 contain related information.

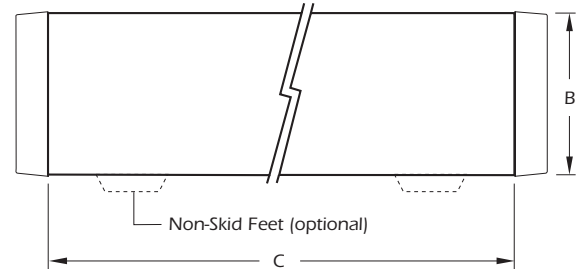
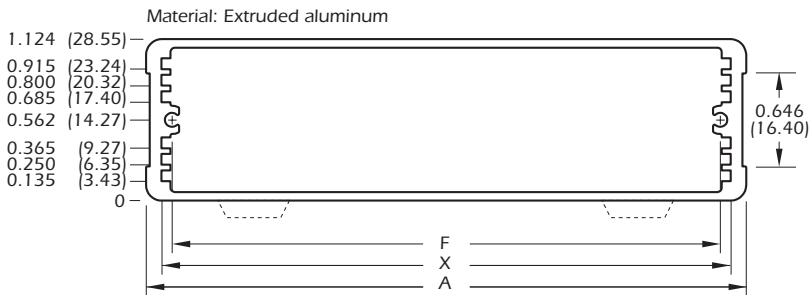
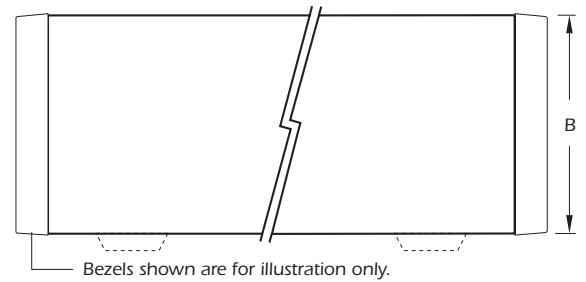
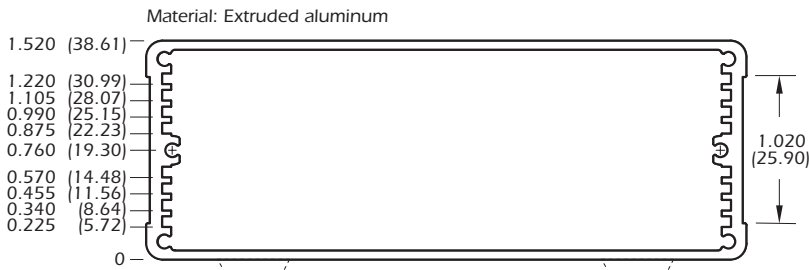

Body Series D

Technical Support
Contact us for assistance and answers to your questions. See page 9 for contact information.



End Configuration Options for Q and T Widths

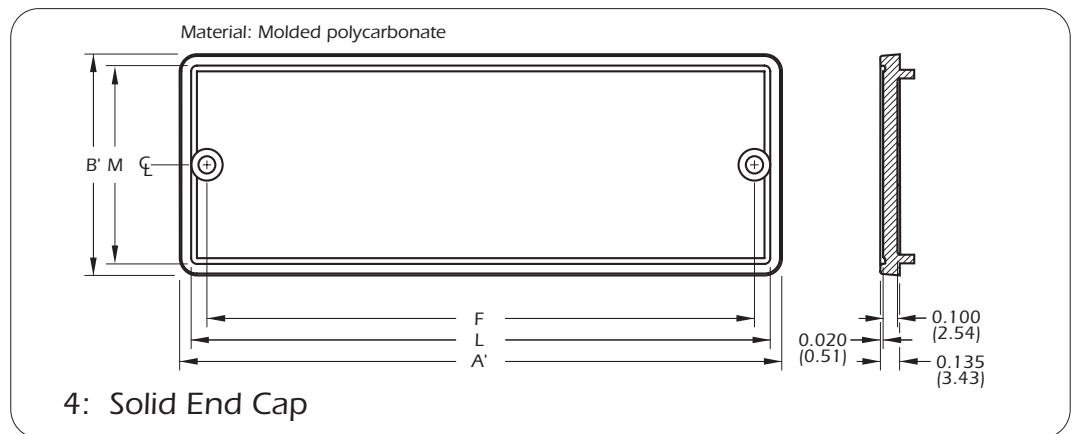
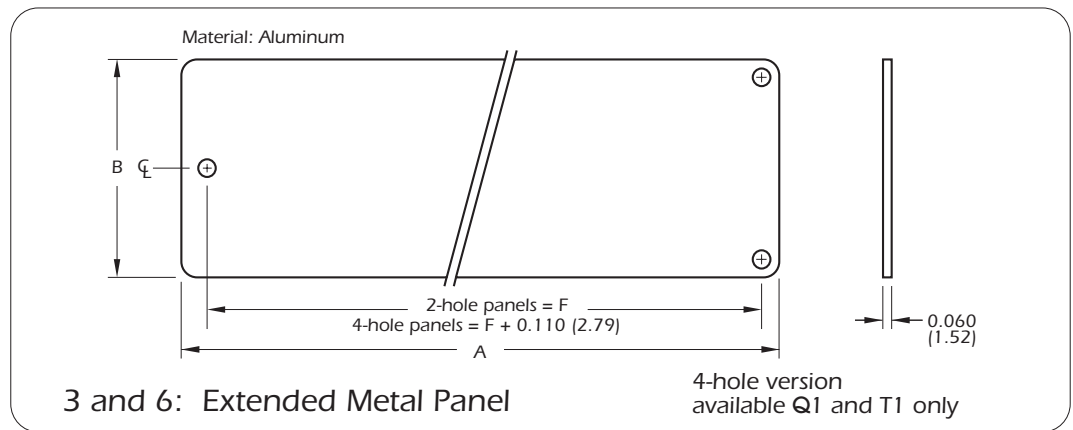
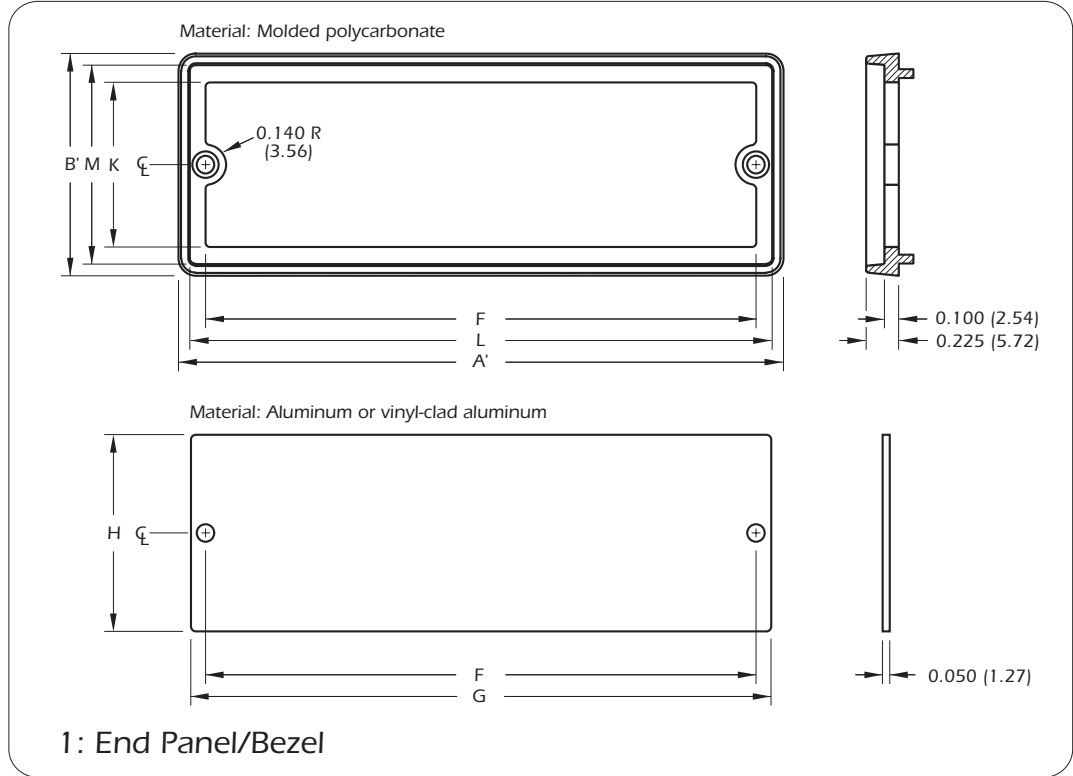
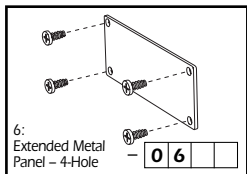
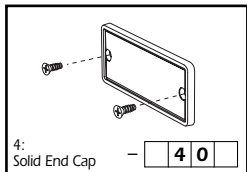
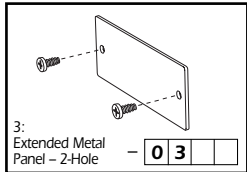
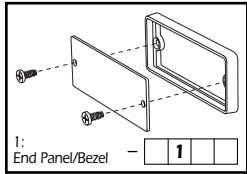

Technical Support
Contact us for assistance and answers to your questions. See page 9 for contact information.



Inch Dimensions (in)

Width & Height	Outline Dimensions				Part Dimensions									PCB Dimensions		
	A Width	B Height	C* Length of Cover/Base	D** Non-Skid Foot Height Optional	A' Molded Part Width	B' Molded Part Height	F Hole Centers	G End Panel Width	H End Panel Height	J Bezel Opening Width	K Bezel Opening Height	L Bezel/End Cap Recess Width	M Bezel/End Cap Recess Height	X*** PCB Width	Y PCB Length	Z Height Above PCB
N1	2.750	0.750	3.00 4.00 5.00 6.00	0.10	2.770	0.770	2.390	2.596	0.596	Same as F	0.500	2.610	0.610	2.51	Same as C	Note 1 Below
N2		1.124	1.144			0.970			0.874		0.984					
Q0	4.175	1.124	5.00 6.00 6.30	0.12	4.195	1.144	3.815	4.021	0.970	Same as F	0.804	4.035	0.984	3.94 Euro card	Same as C	Note 1 Below
Q1		1.520	1.540			1.366			1.140		1.380					
T0	5.528	1.124	6.00 7.00	0.12	5.548	1.144	5.168	5.374	0.970	Same as F	0.804	5.388	0.984	5.28	Same as C	Note 1 Below
T1		1.520	1.540			1.366			1.140		1.380					

*Dimensions shown above are stock sizes. Dimension C can be varied to meet customer requirements.

**Bumpoms are not standard in the D Series. Suggested sizes are shown. See page 8 for full outline drawings.

***Clear opening between extrusion details = X minus 0.23 in.

Note 1: Height above PCB varies with track selected.

Panel Overlays (Recommended Dimensions)	
Overlay Height	"H" plus 0.010
Overlay Width	"G" plus 0.010
Corner Radius	0.038

Tolerance = ± 0.005

Metric Dimensions (mm)

Width & Height	Outline Dimensions				Part Dimensions									PCB Dimensions		
	A Width	B Height	C* Length of Cover/Base	D** Non-Skid Foot Height Optional	A' Molded Part Width	B' Molded Part Height	F Hole Centers	G End Panel Width	H End Panel Height	J Bezel Opening Width	K Bezel Opening Height	L Bezel/End Cap Recess Width	M Bezel/End Cap Recess Height	X*** PCB Width	Y PCB Length	Z Height Above PCB
N1	69.8	19.1	76.2 101.6 127.0 152.4	2.5	70.4	19.6	60.7	65.9	15.1	Same as F	12.7	66.3	15.5	63.7	Same as C	Note 1 Below
N2		28.5	29.0			24.6			22.2		25.0					
Q0	106.0	28.5	127.0 152.4 160.0	3.1	106.6	29.0	96.9	102.1	24.6	Same as F	20.4	102.5	25.0	100.0 Euro card	Same as C	Note 1 Below
Q1		38.6	39.1			34.7			28.9		35.0					
T0	140.4	28.5	152.4 177.8	3.1	140.9	29.0	131.3	136.5	24.6	Same as F	20.4	136.9	25.0	134.1	Same as C	Note 1 Below
T1		38.6	39.1			34.7			28.9		35.0					

*Dimensions shown above are stock sizes. Dimension C can be varied to meet customer requirements.

**Bumpoms are not standard in the D Series. Suggested sizes are shown. See page 8 for full outline drawings.

***Clear opening between extrusion details = X minus 5.8 mm.

Note 1: Height above PCB varies with track selected.

Panel Overlays (Recommended Dimensions)	
Overlay Height	"H" plus 0.25
Overlay Width	"G" plus 0.25
Corner Radius	0.97

Tolerance = ± 0.12



Model Numbers for Standard Enclosures:

Make your configuration selections and transfer the alpha-numeric codes to the appropriate boxes in the model number below. Fill in any empty boxes with choices from the tables. The resulting model number completely specifies the D Style MicroPak of your choice. The price of this model number can be found on page 2 of our separate MicroPak Price List. Ordering information can be found on page 5 of that same document.

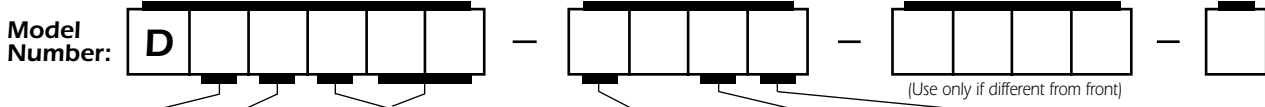
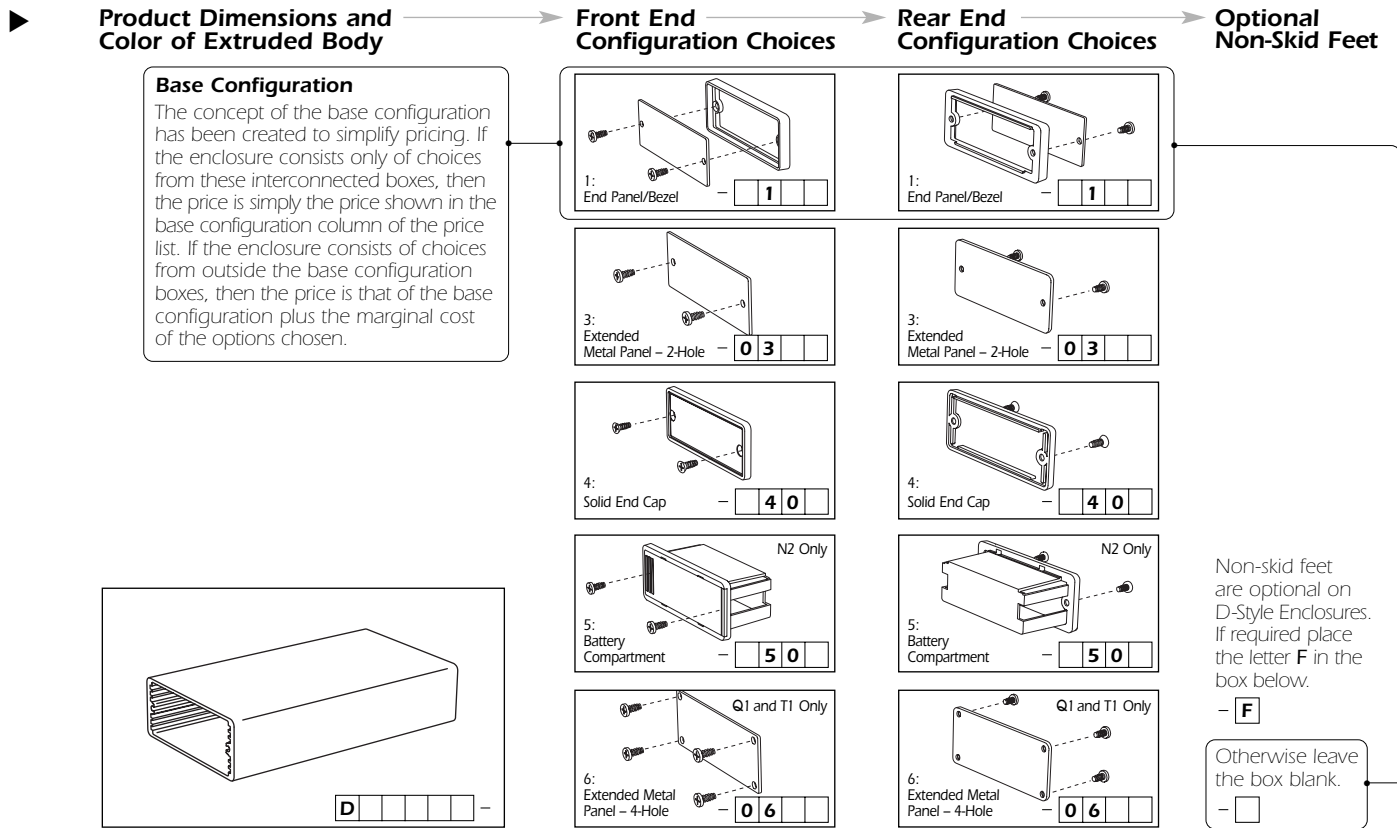

Dimensions - inch (metric)		
Width	Height	Length
N = 2.75 (69.8)	1 = 0.75 (19.1)	30 = 3.00 (76.2)
	2 = 1.12 (28.4)	40 = 4.00 (101.6)
Q = 4.17 (106.0)	0 = 1.12 (28.4)	50 = 5.00 (127.0)
	1 = 1.52 (38.6)	60 = 6.00 (152.4)
		63 = 63.0 (160.0)
T = 5.53 (140.4)	0 = 0.52 (28.4)	60 = 6.00 (152.4)
	1 = 1.52 (38.6)	70 = 7.00 (177.8)

Color Choices	
Extruded Body	Bezel, End Cap, Battery Comp.
A = Clear Anodize	*
K = Black Anodize	*
C = Clear Iridite	*
P = Pearl White	= P
E = Pebble Gray	= E
* = Shale Gray	= S
T = Platinum	= T
G = Medium Gray	= G
B = Black	= B
* = Nickel Acrylic	= N
* Not available	

End Panel Choices	
Aluminum	
A = Clear Anodize	
C = Clear Iridite	
B = Black Anodize	
R = Raw Aluminum with vinyl protection	
Vinyl-clad Aluminum	
P* = Pearl White	
E* = Pebble Gray	
T* = Platinum	
G* = Medium Gray	
K* = Black	
X = No end panel	
* Not available on end configurations "3" and "6"	

Screw Choices	
Standard (3/8" long)	
1* = Pan Head	Silver
2* = Pan Head	Black
3* = Flat Head	Silver
4* = Flat Head	Black
Optional (5/8" long)	
6* = Pan Head	Silver
7* = Pan Head	Black
8* = Flat Head	Silver
* Not available on end configurations "4" and "5"	
* Not available on end configurations "3" and "6"	

Model and Part Numbers for Customized Enclosures and Parts:

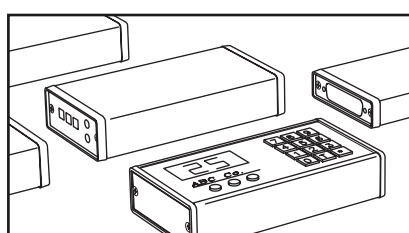

Each **customized enclosure** is assigned a model number in the following format:

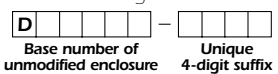

Associated with this model number is a bill of materials that identifies each individual part, standard or customized, making up the complete unit. Customized enclosures may be ordered by this model number or by individual part numbers.

Each **customized part** is assigned a part number in the following format:

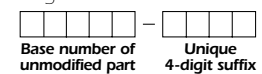

This number is assigned when an order is placed. A master drawing, used for manufacture and inspection, is then created for each part. This drawing is submitted for customer approval before the part can be manufactured.



D Style MicroPak

Accessories

Rack Mount Panels

All MicroPak Enclosures can be mounted in a standard 19-inch rack by using a Rack Mount Panel. The 14 stock varieties of Rack Mount Panels for mounting D Style plus two sizes of blank panel are shown below. Other configurations are available on special order. The model number associated with each variety is for a clear anodize finish. For black anodize, change the last "A" to a "B".

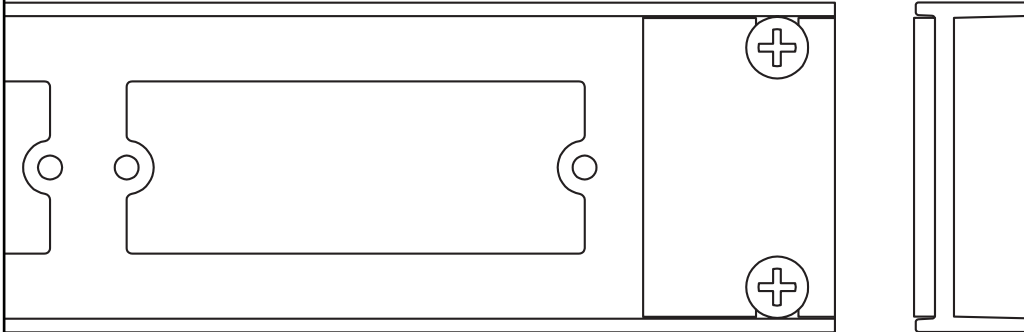

Detail from Model K1PCN2-H06A (seen below) and extrusion cross section. Also shown is one of two required spacers that are included with each Rack Mount Panel.

N Width

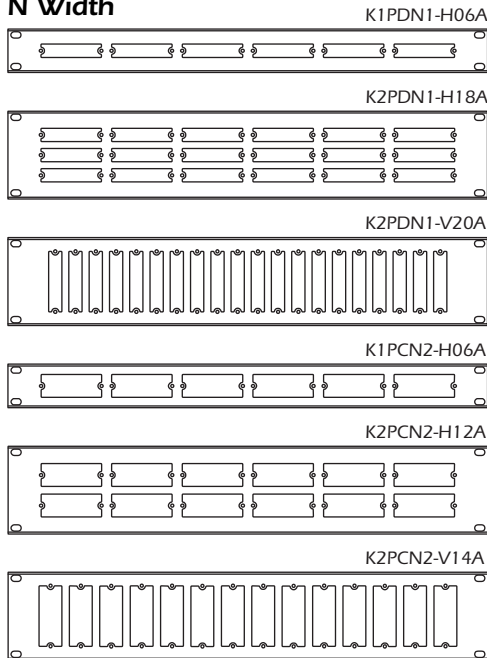

Q Width

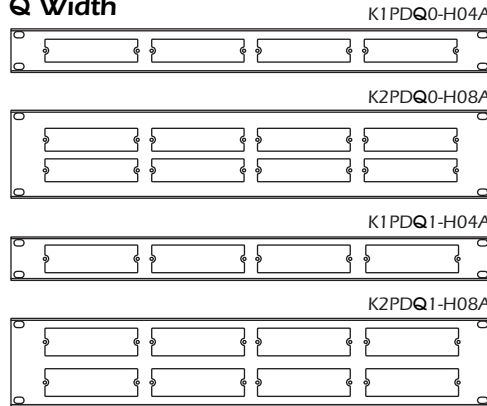

T Width

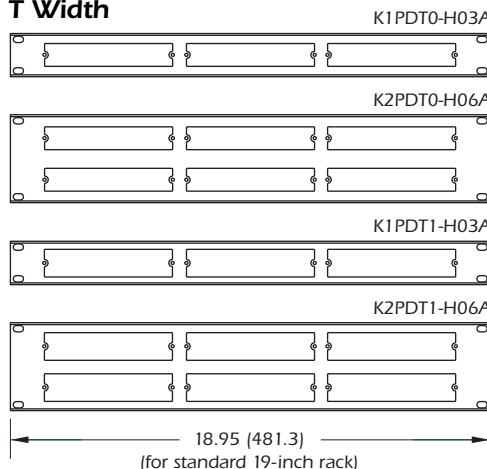

Blank Panels

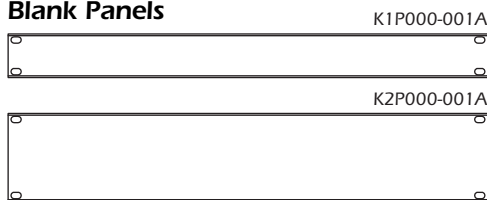

18.95 (481.3)
(for standard 19-inch rack)

Note: Pricing for these Rack Mount Panels can be found on page 4 of our separate MicroPak Price List. Ordering information can be found on page 5 of that same document.

Non-Skid Feet

Self-adhesive black feet. Sold individually.

Model Numbers: KFT10-BLK 0.10 (2.5) tall
KFT12-BLK 0.12 (3.1) tall
KFT23-BLK 0.23 (5.8) tall

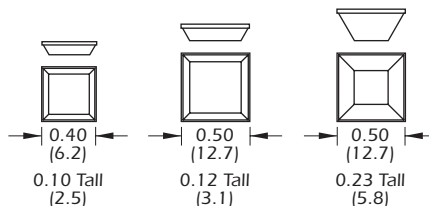

Refer to our **MicroPak Brochure** for detailed narrative and full-color photos.



Price List
Find MicroPak prices.

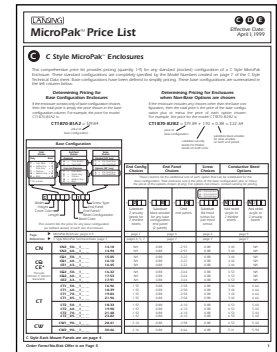

Order Form/Sample Offer
Place an order or purchase a sample MicroPak at a special introductory no-risk offer price.

Technical Support
Contact us for assistance and answers to your questions.

How to Contact Lansing

Phone:
800-847-3535
Anywhere in the U.S. or Canada
607-272-3265

Fax:
607-277-1953

Visit our website:
www.lansing-enclosures.com

E-mail:
info@lansing-enclosures.com

Mail:
Lansing Instrument Corp.
PO Box 730
Ithaca, NY 14851-0730

